

# NEWMAN

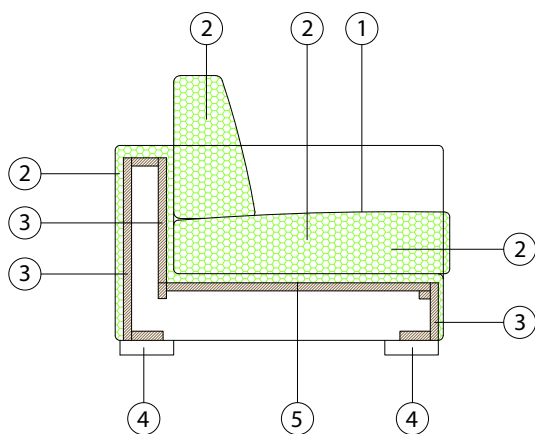

Newman is a modern upholstered sofa from the ground, and, if necessary, a sofa bed. It is a compilable collection of different sizes of modules and a coffee table that can serve as a coffee table or a jamb in compositions. Also available in ground floor version with wooden feet. Minimal, rigorous, deliberately exaggerated depths, backed or extremely soft back cushions, regular size and oversized penisers and small tables make the Newman modular collection a timeless contemporary home.



NEWMAN WOOD

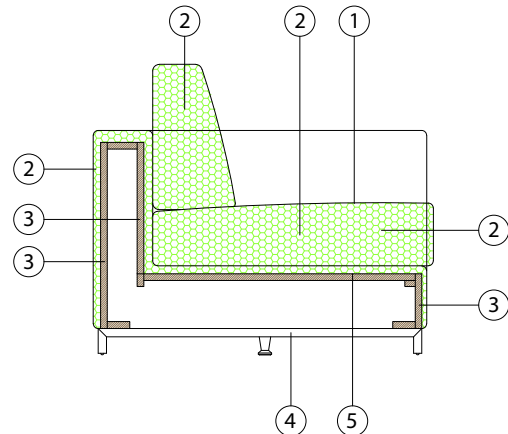

NEWMAN STEEL

- 1 - fabric/leather;
- 2 - high resilience polyurethane foam of different densities and dacron® fiber 100 gr layer;
- 3 - structural frame in composite wood;
- 4 - WOOD: stained wengè wooden feet P 14, h 6 cm/  
SOFA BED WOOD VERSION: stained wengè wooden feet P 50, h 6 cm  
STEEL: circular tubular plated chrome metal frame P 23, h 8 cm.
- 5 - elastic webbing.

# NEWMAN



## DIMENSIONS

### Wood

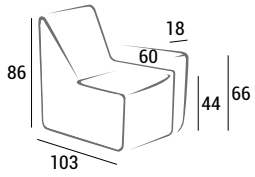

### Steel

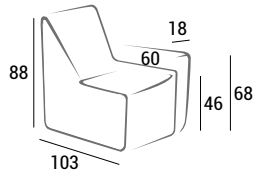

2S

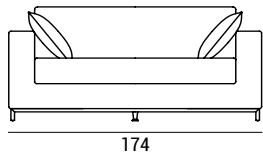

174



2S R-L

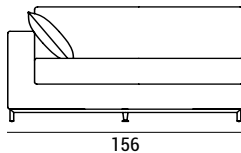

156



2S NO ARMRESTS

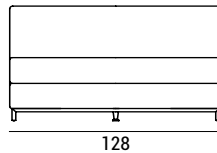

128

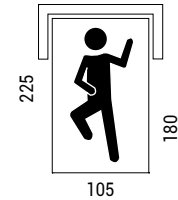

105

3S

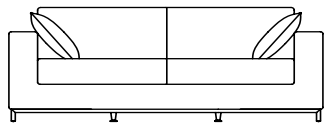

204



3S R-L

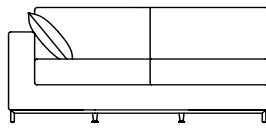

186



3S NO ARMRESTS

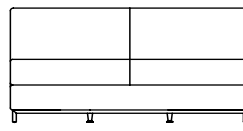

168

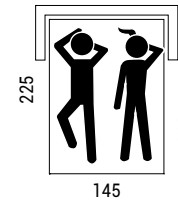

145

4S

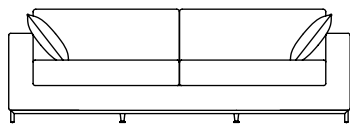

253



4S R-L

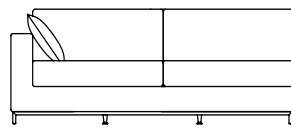

235



4S NO ARMRESTS

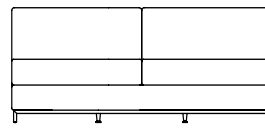

217

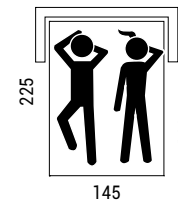

145

SOFA BED VERSION  
Polyurethane mattress, h 8 cm, covered with antiallergic fabric. High-resistance steel electrowelded mechanism with three-fold mechanism.

CORNER

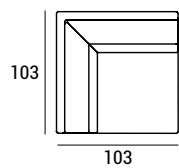

103

SMALL PENINSULA R-L

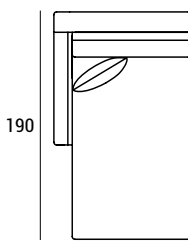

115



BIG PENINSULA R-L

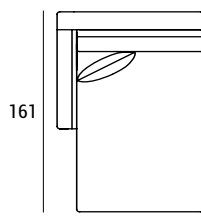

137



POUF

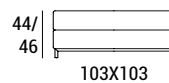

103X103

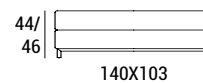

140X103

### Side tables

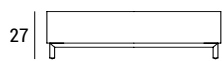

104X90

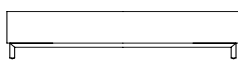

120X104

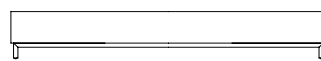

180X104

### MATERIALS

Polished lacquered  
MDF top

# NEWMAN



## SIDE TABLE FINISHINGS

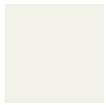

RAL 9016



RAL 7015



RAL 7044

RAL COLOR OF YOUR CHOICE



## SOFA BED VERSION SURCHARGE

FOOT FOR  
SOFA BED  
VERSION



P 50 h 8 cm  
Stained wengé wooden  
foot

2S

24 kg

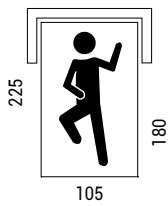

3S

29 kg

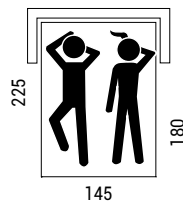

4S

29 kg

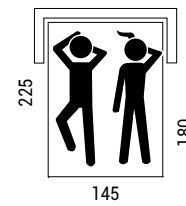

## MECHANISM SOFA BED

### Opening

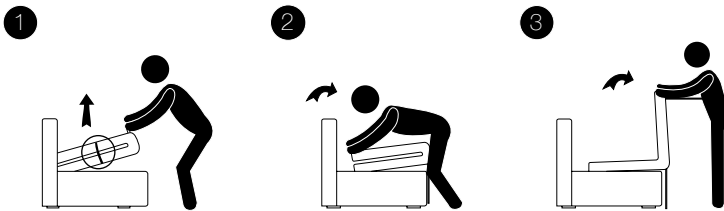

REMOVE  
cable ties on the sides before  
lifting the sleeping deck

Opening folding the bed  
incorrectly could damage  
the mechanism

### Closing

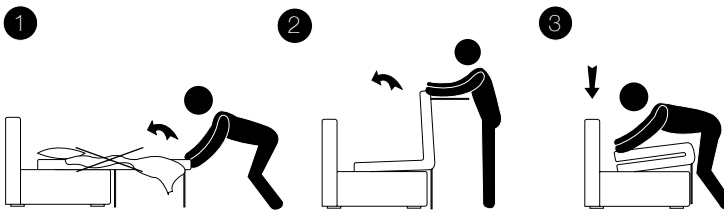

REMOVE  
all sheet, blankets and pillows  
before folding the sofa back up to  
avoid breaking the mechanism

## FEET

Wood



P 14

Steel







P 50  
Only available for  
sofa bed version



P 23



## TECHNICAL DETAILS

			 fabric mtl H 140 cm	 leather m <sup>2</sup>
2S	55	1.58	10.40	19.34
2S R-L	48	1.42	8.40	15.62
2S NO ARMRESTS	40	1.26	6.40	11.90
3S	71	1.85	11.70	21.76
3S R-L	63	1.69	10.00	18.60
3S NO ARMRESTS	55	1.53	8.50	14.88
4S	96	2.30	12.90	23.99
4S R-L	88	2.14	10.90	20.27
4S NO ARMRESTS	80	1.97	8.90	16.55
CORNER	42	0.94	7.50	13.95
SMALL PENINSULA R-L	68	1.93	9.60	17.86
BIG PENINSULA R-L	62	1.94	9.70	18.04
POUF 103X103	16	0.51	4.30	8.00
POUF 140X103	26	0.66	5.10	9.49
SIDE TABLE 104X90	19	0.27	/	/
SIDE TABLE 120X90	29	0.36	/	/
SIDE TABLE 180X90	38	0.53	/	/