



DOYLE



Doyle is a collection of modern upholstered sofas, featuring a system of bookcases and storage compartments hanging sideways or at the back of all the items in the collection. Available on feet or terrain version, regular and maxi depths. It is the evolution of the monocoque sofa, whose features are characterized by soft and deep seating, which resemble almost the gummy candy.

- 1 - seating: padding in feather, backrest: feather;
- 2 - high resilience polyurethane foam of different densities;
- 3 - structural frame in plywood;
- 4 - structural frame in HDF;
- 5 - hidden feet P 25 in black ABS, h 2 cm/
plated metal chrome feet P 30, h 4.5 cm.

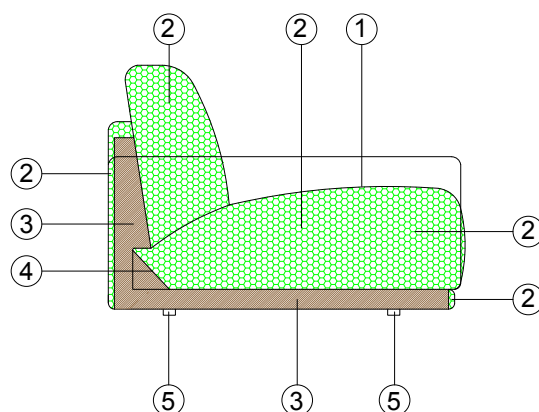



DIMENSIONS

Regular

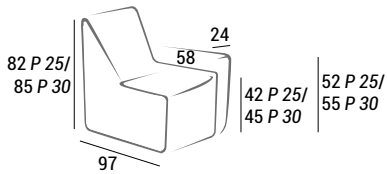

Maxi

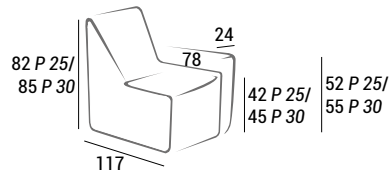

1S

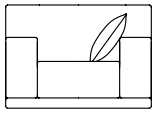

115

45x45
x1

1S R-L

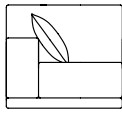

90

45x45
x1

1S NO ARMRESTS

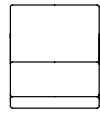

65

2S

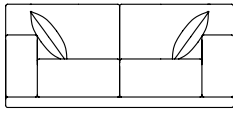

180

45x45
x2

2S R-L

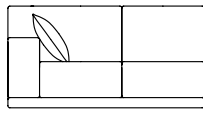

155

45x45
x1

2S NO ARMRESTS

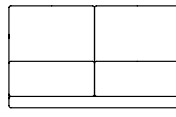

130

3S

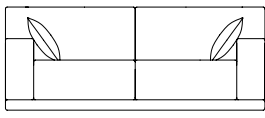

230

45x45
x2

3S R-L

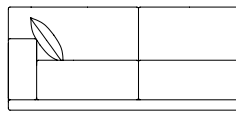

205

45x45
x1

3S NO ARMRESTS

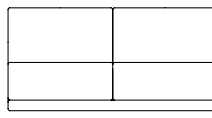

180

4S

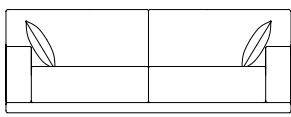

281

45x45
x2

4S R-L

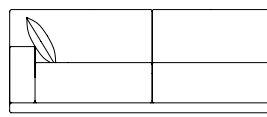

256

45x45
x1

4S NO ARMRESTS

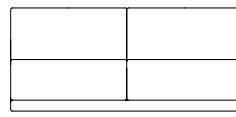

231

DOYLE



Regular

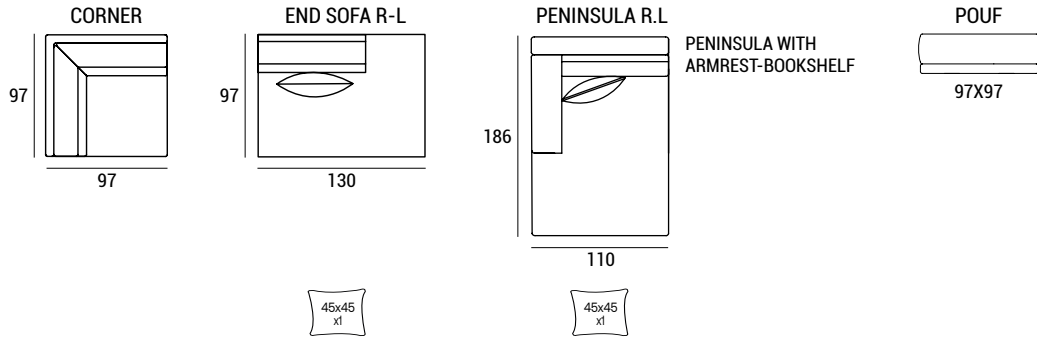

Maxi

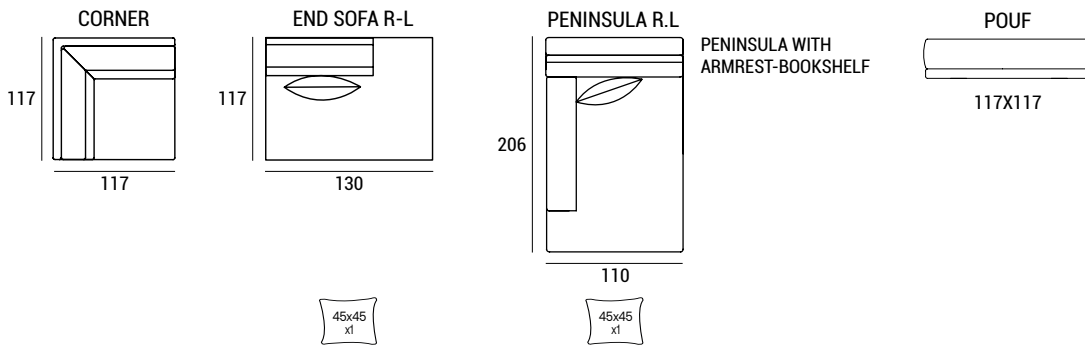

Accessories for platforms

Regular

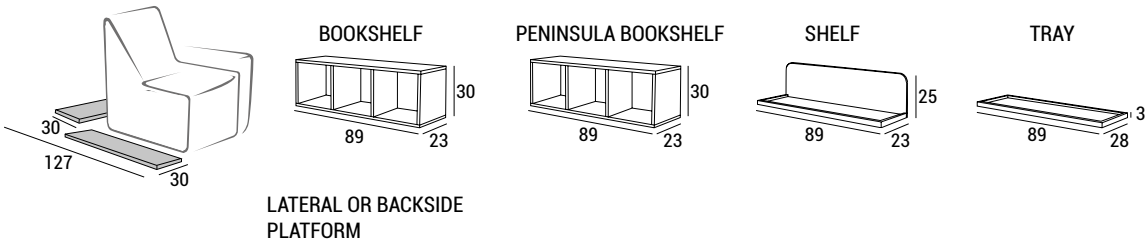

LATERAL OR BACKSIDE PLATFORM

MATERIALS

Wengè veneered wood or satin semi-transparent tinted glass

Maxi

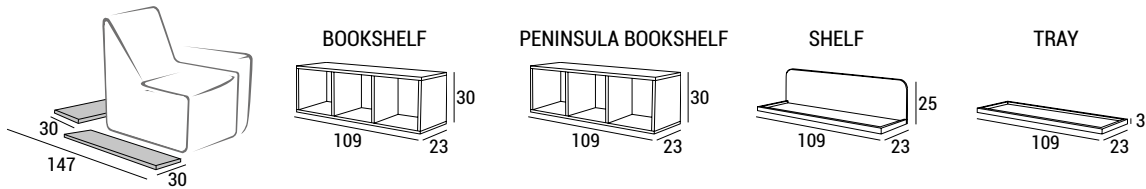

FEET

Included in the price, at the customer's choice



P 25



P 30







TECHNICAL DETAILS

			 fabric mtl H 140 cm	 leather m ²
REGULAR 1S	48	0.94	9.40	17.48
MAXI 1S	58	1.17	10.60	19.72
1S BACK PLATFORM	1	0.03	0.80	1.49
REGULAR 1S R-L	38	0.74	7.20	13.39
MAXI 1S R-L	46	0.92	7.80	14.51
1P DX-SX BACK PLATFORM	1	0.02	0.80	1.49
REGULAR 1S NO ARMRESTS	28	0.54	4.50	8.37
MAXI 1S NO ARMRESTS	34	0.67	5.10	9.49
1P CENTRALE PIAT. LAT.	0.8	0.02	0.80	1.49
REGULAR 2S	71	1.47	12.70	23.62
MAXI 2S	86	1.83	13.90	25.85
2P BACK PLATFORM	1.5	0.04	1.30	2.42
REGULAR 2S R-L	61	1.27	10.00	18.60
MAXI 2S R-L	74	1.57	11.20	20.83
2P DX-SX BACK PLATFORM	1.2	0.04	1.30	2.42
REGULAR 2S NO ARMRESTS	51	1.07	7.30	13.58
MAXI 2S NO ARMRESTS	62	1.32	8.50	15.81
2S NO ARMRESTS BACK PLAT.	1.3	0.03	0.80	1.49
REGULAR 3S	93	1.88	14.00	26.04
MAXI 3S	112	2.33	15.20	28.27
3P BACK PLATFORM	2.3	0.05	1.30	2.42
REGULAR 3S R-L	83	1.68	11.50	21.39
MAXI 3S R-L	100	2.08	12.70	23.62
3S R-L BACK PLATFORM	2	0.05	1.30	2.42
REGULAR 3S NO ARMRESTS	73	1.47	8.80	16.37
MAXI 3S NO ARMRESTS	88	2.08	10.00	18.60
3S NO ARMRESTS BACK PLAT.	1.8	0.04	1.30	2.42
REGULAR 4S	110	2.29	17.30	32.18
MAXI 4S	132	2.85	18.50	34.41
4S BACK PLATFORM	2.8	0.07	1.80	3.35
REGULAR 4S R-L	110	2.29	15.50	23.83
MAXI 4S R-L	125	2.59	16.70	31.06
4S R-L BACK PLATFORM	2.5	0.06	1.30	2.42
REGULAR 4S NO ARMRESTS	94	1.89	13.00	24.18
MAXI 4S NO ARMRESTS	113	2.34	14.20	24.61
4S NO ARMRESTS BACK PLAT.	2.3	0.05	1.30	2.42
REGULAR CORNER	40	0.80	7.40	13.74
MAXI CORNER	48	1.19	8.00	14.88
CORNER BACK PLATFORM	2.7	0.03	1.80	3.35
REGULAR END SOFA R-L	51	1.07	6.50	12.09
MAXI END SOFA R-L	62	1.32	7.10	13.21
END SOFA R-L BACK PLAT.	1.3	0.03	0.80	1.49
REGULAR PEN. R-L WITH ARM.	69	0.89	7.70	14.32
REGULAR PEN. R-L BOOK.	89	0.89	6.70	12.46
MAXI PEN. R-L WITH ARM.	73	1.05	8.30	15.44
MAXI PEN. R-L WITH BOOK.	93	1.05	7.80	14.51



DOYLE

			 fabric mtl H 140 cm	 leather m ²
PENINSULA R-L BACK PLAT.	1	0.03	0.80	1.49
REGULAR POUF	15	0.41	4.80	8.93
MAXI POUF	18	0.63	5.40	10.04
GLASS BOOKSHELF	20			
WOODEN BOOKSHELF	15			
GLASS SHELF	15			
WOODEN SHELF	10			
GLASS TRAY	10			
WOODEN TRAY	5			